

1/5

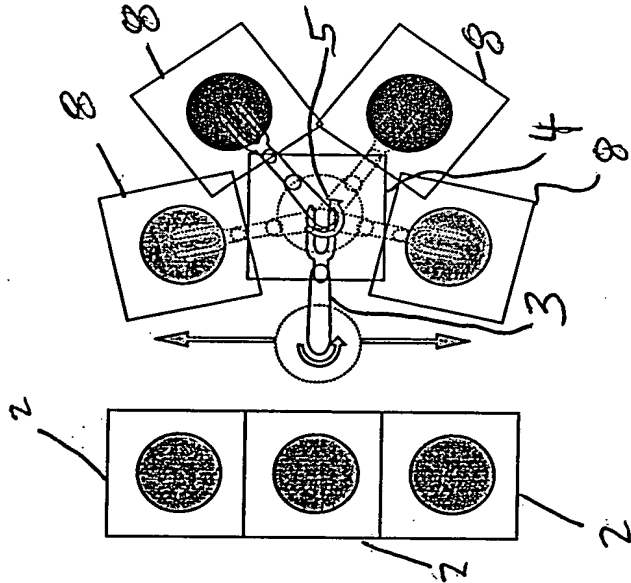

FIG. 1C

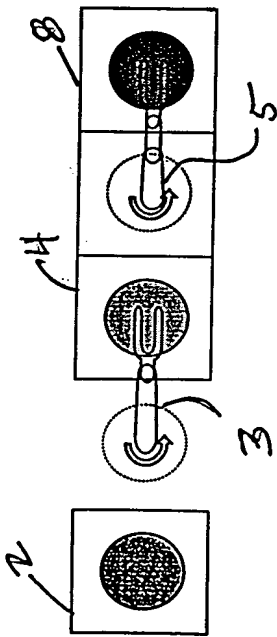

FIG. 1A

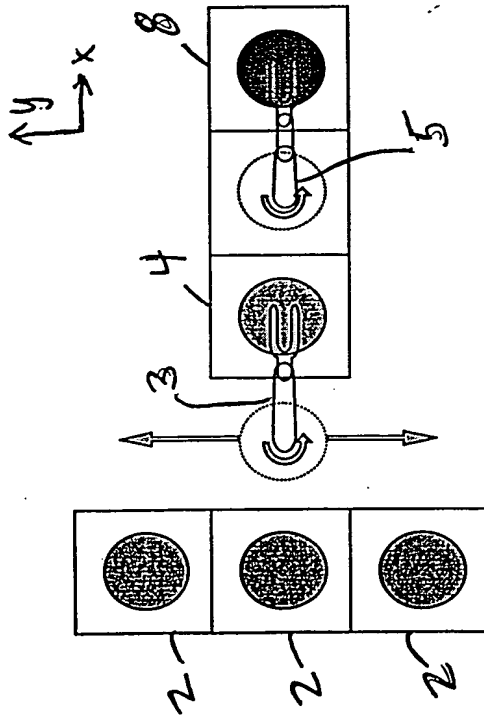

FIG 1B

FIG. 1A

FIG. 1B

FIG. 1C

3/5

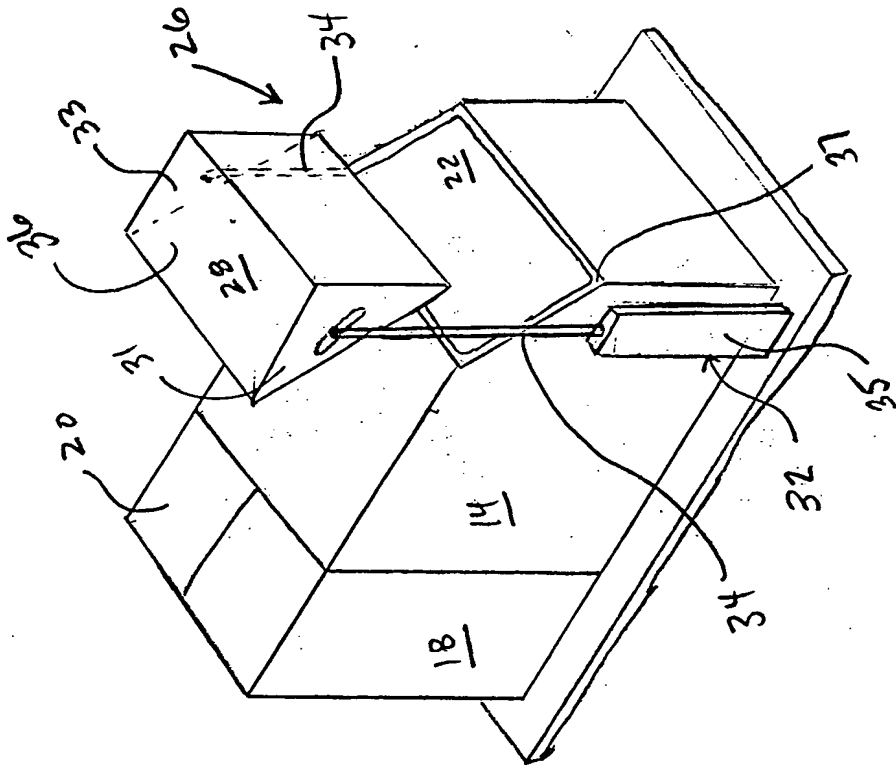
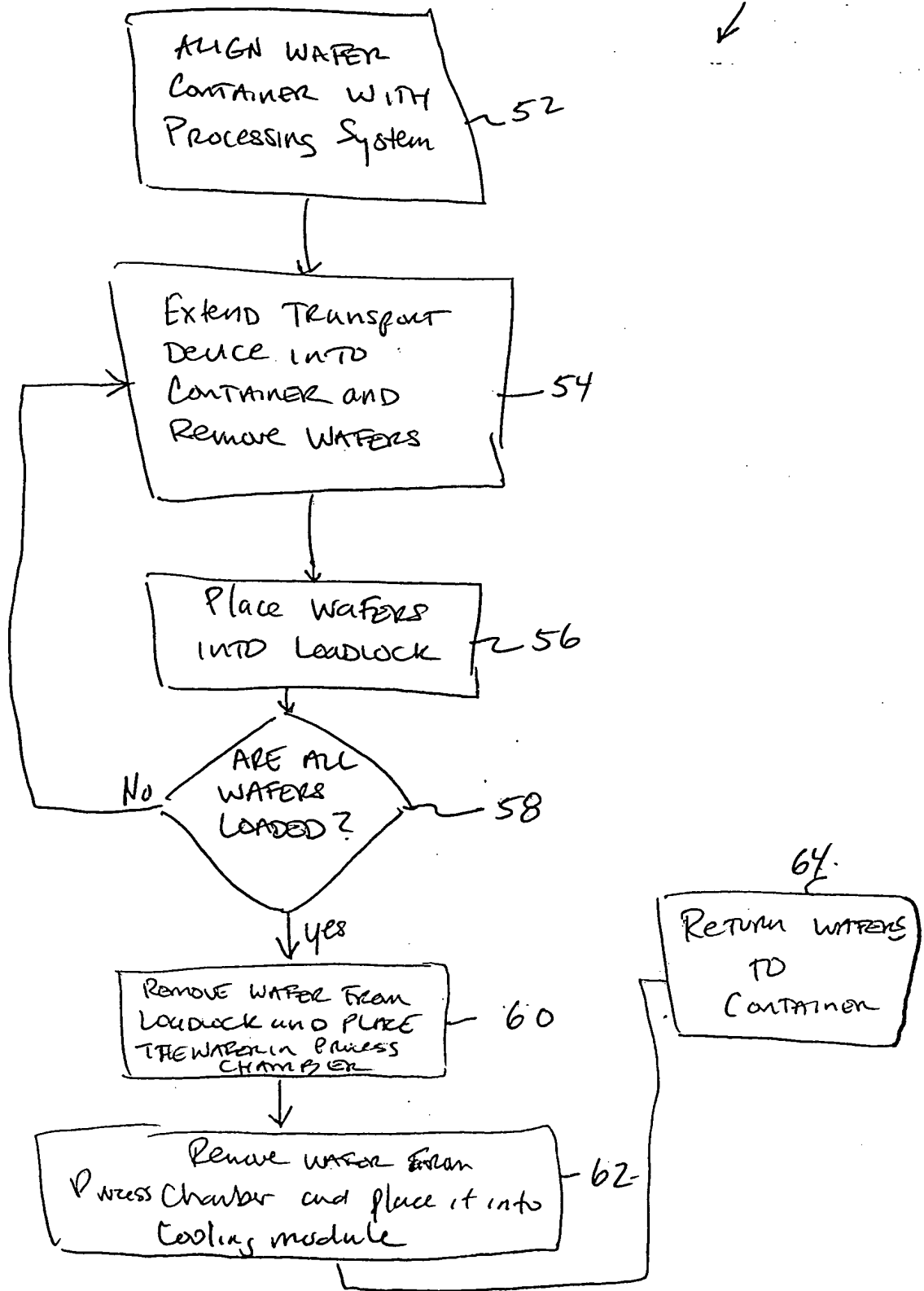

FIG. 3

FIG. 3

4/5

50
↓



FOR "FO" E208282

FIG. 4

5/5

FIG. 10

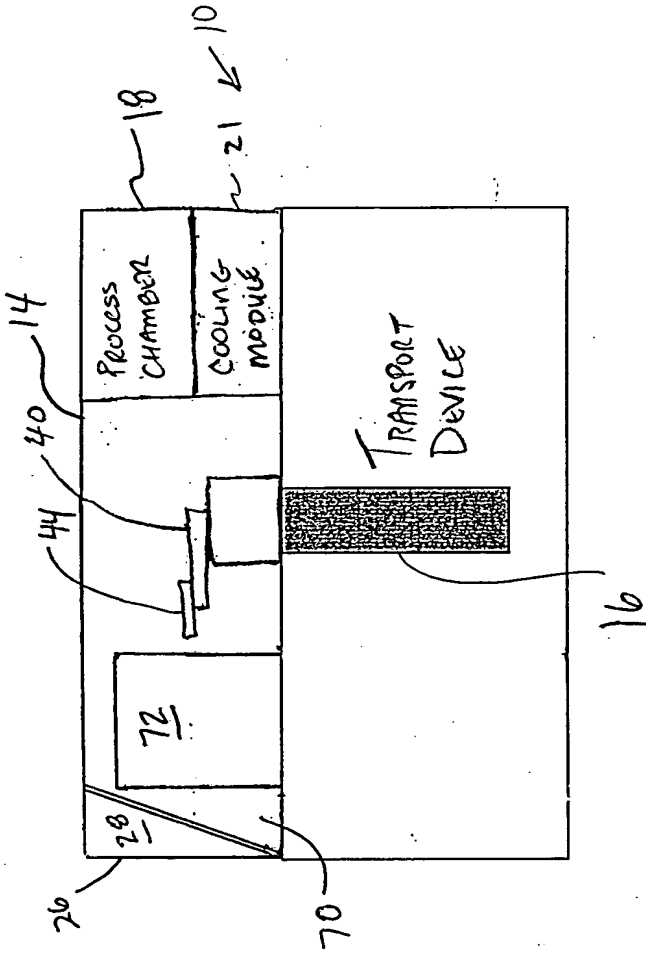

FIG. 5A

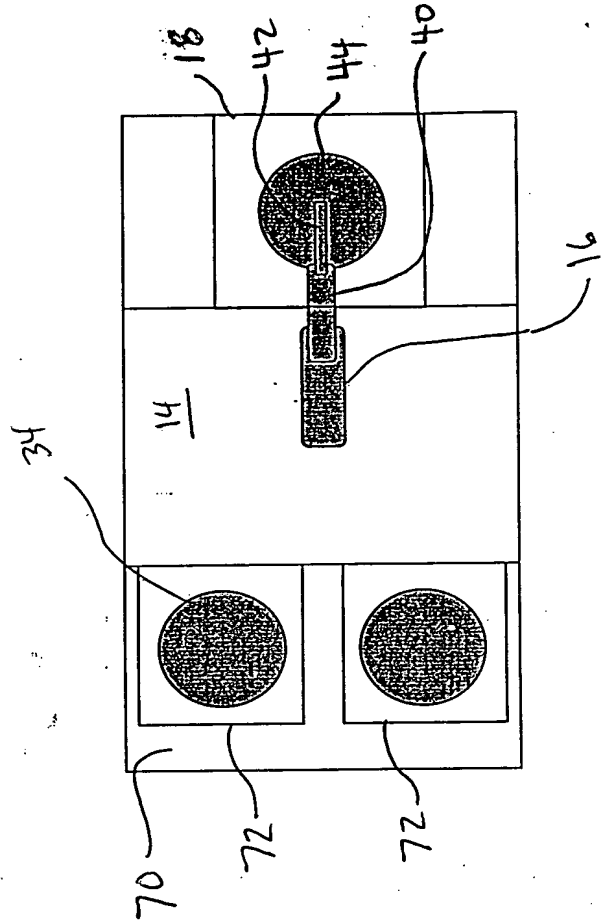

FIG. 5B